

# Tech Writing Handbook

## Authors

Kyle Wiens, CEO, iFixit

Julia Bluff, Lead Writer, iFixit

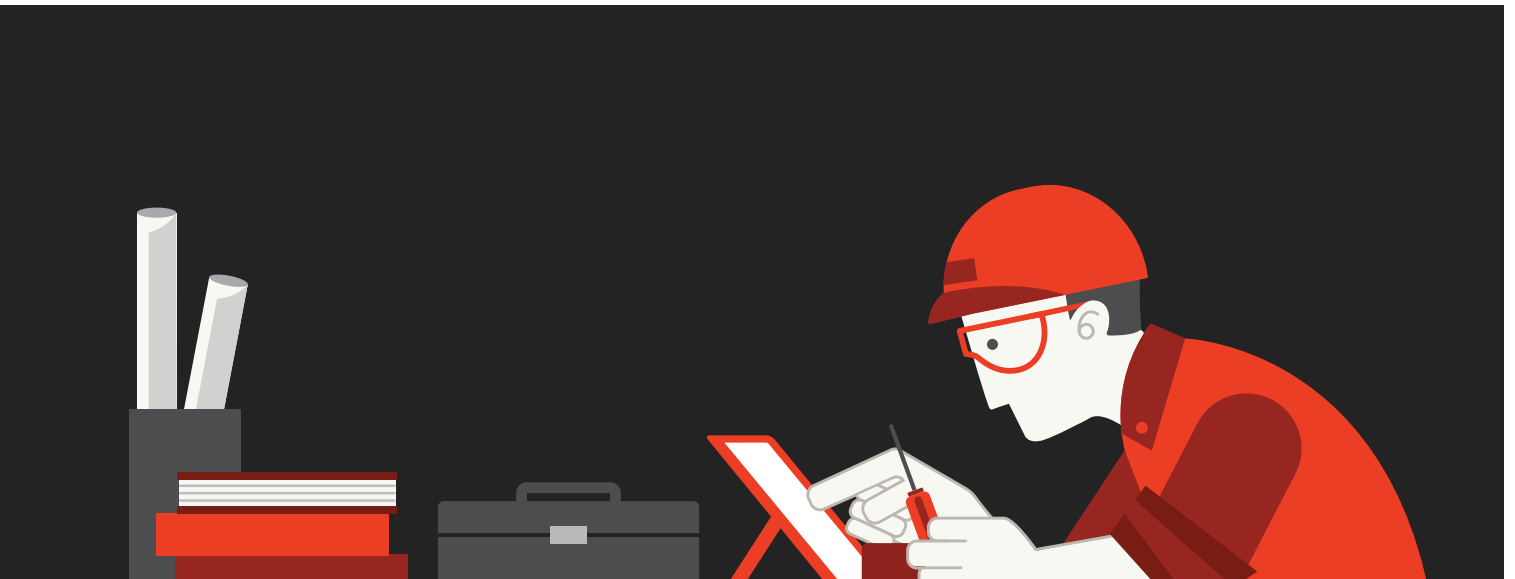













# Tech Writing Handbook

This handbook will teach you how to create everything from manuals to work instructions. We'll help you avoid the most common pitfalls of tech writing, from poor planning to outdated publishing.

## Authors

Kyle Wiens, CEO, iFixit

Julia Bluff, Lead Writer, iFixit

	Chapter 0 <b>Welcome!</b> .....	3
	Chapter 1 <b>Look before you write</b> .....	5
	Chapter 2 <b>Be concise</b> .....	7
	Chapter 3 <b>Crystal clarity</b> .....	10
	Chapter 4 <b>Communicate with style</b> .....	13
	Chapter 5 <b>Know your audience</b> .....	17
	Chapter 6 <b>Photograph the process</b> .....	19
	Chapter 7 <b>Use visuals</b> .....	25
	Chapter 8 <b>Organize your content</b> .....	30
	Chapter 9 <b>Legal requirements</b> .....	34
	Chapter 10 <b>How to publish</b> .....	36
	Chapter 11 <b>After you write</b> .....	40
	Appendix A: Deep dive <b>Manufacturing work instructions</b> .....	42

Brought to you by **DOZUKI**



## CHAPTER 0

# Welcome!

So, you've decided to write a manual. We extend our hand in hearty congratulations of the do-it-yourself moxie that led you here. Welcome to the world of technical communication!

---



Now, at this very moment, you may be chuckling to yourself, “Technical communication ... Isn't that an oxymoron?”

We get it. Bad manuals happen ... a lot. It's a universal experience: You take Junior's Christmas gift out of the box, crack open the assembly manual, and, suddenly, everything goes horribly, horribly wrong. Three hours later, all you have to show for your effort is a mutant tricycle. Junior will not be pleased.

The best way to learn something is to have an expert teach you. But manuals are the next best thing. Great manuals, like the ones from iFixit or Mackie, are teachers.

And we suspect that's why you're here. You want to write a manual that actually teaches people how to do things.

We want to help. This program will teach you how to write how-to guides, work instructions, and service manuals — from planning, to writing, to publishing. We'll also help you avoid the most common pitfalls of tech writing.

Manuals are important. Whether you're writing about how to perform maintenance on a CNC machine, use video editing software, bake a soufflé, or rebuild an engine, you're teaching someone something new. If your manual succeeds, the reader will have done something that wasn't possible without your help. And that's pretty amazing.

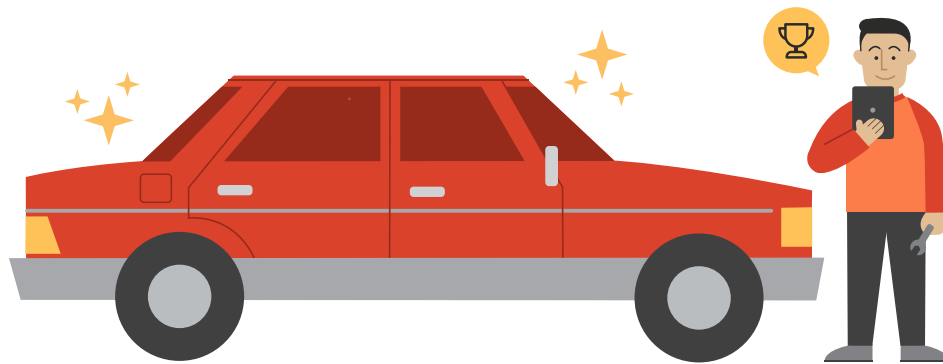



## CHAPTER 1

## Look before you write

Writing effective instructions is an achievement. Modern instructions shouldn't just be a list of useful directions. They embrace the aesthetic and conventions of our time: highly visual, sleek, interactive, and well-designed. And when they're done right, they're a pathway to empowerment.

---

Right now, you're probably excited to get writing. But before you start galloping off into the tech writing sunset, know this: most of the manuals and guides out there are written by people who have no firsthand knowledge of the subject matter. We think that's a problem. It takes more than just writing skill to write a good manual: it also takes understanding. There are two laws of tech writing:

- 1. Know thy product and process**
- 2. Talk to thy experts**

### Know thy products and process

The first requirement for tech writing is knowledge. You can't teach someone how to do something until you've done it yourself. If you're writing assembly instructions, put the product together. If you're writing about software, use the program. If you're writing a product manual, you should know the product inside and out. Use it, take it apart, figure out how it works and what it's meant to do.

Once you think you know the process, try to teach it to someone else. Teaching is a great way to solidify your knowledge, and what you learn from watching your student struggle will make your manual better.

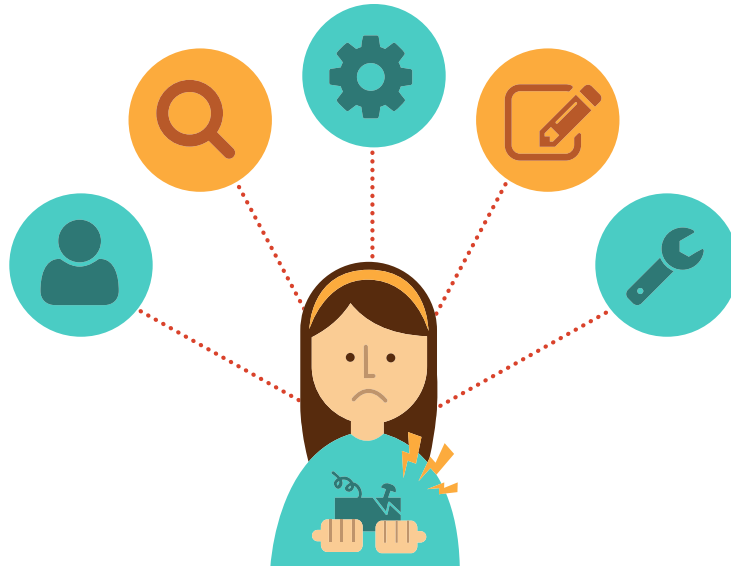

### Talk to thy experts

If you're not an expert at what you're writing about, talk to someone who is. Chat with the developers, technicians, or designers. Ask them to give you a walkthrough of the product, process, or software. Ask them how it's made, how it's done, and why things are the way they are. Then, keep asking if you need more help.

Glean as many stories from them as you can. Understanding the process that goes into making something will clarify your understanding.

### How manuals are usually written

Tech writers create a first draft based on initial functional specifications. Of course, the real product barely resembles the spec by the time the manual is written. The first draft is a total waste of time. As part of the frustrating review process, engineers give the writers hand scribbled notes. Tech writers assemble another draft, which engineers promptly rip apart. And the process starts over again. Finally, the document is published.

But it doesn't have to be that way. The faster and more frequent the interactions between engineer and writer, the better the final product will be.



## CHAPTER 2

## Be concise

Style tip #1: Be direct and get to the point. Then stop writing.

---

That rule applies doubly if you're writing for the internet. Chrome, Safari, and Firefox are all called web browsers instead of web readers for a reason. People don't read web pages. They scan, hunting and pecking for words and phrases that they find pertinent. The average person spends just seconds on a web page, reading only about 20% of the text. The more concise you are, the more information readers actually read.

Even paper manuals aren't "well read," in the classic sense. No one curls up at night with a manual. Just like on web pages, people look for the information that they want. The more text-dense manuals are, the less likely people will dig through them.

Check out this example of an actual warranty statement from an actual kitchen appliance:

**Example 1:** We suggest you complete and return the enclosed product registration card promptly to facilitate verification of the date of original purchase. However, return of the product registration card does not eliminate the need for the consumer to maintain the original proof of purchase in order to obtain the warranty benefits. In the event that you do not have proof of purchase date, the purchase date for purposes of this warranty will be the date of manufacture.

It's only three sentences, but it's dense, impersonal, and wordy. Here's our revision:

**Example 2:** Please return your completed product registration card so we can verify your purchase date. Keep the original proof of purchase to secure your warranty benefits. If you don't know the purchase date, give the manufacture date instead.

Isn't that better?

## How to make paragraphs more concise

- **Lead with the most important information:** Front-load useful details. Assume that your reader isn't going to slog through an entire paragraph. When you start with the important stuff, your readers take the essential point with them—even if they don't read everything.
- **Get rid of unimportant information:** Readers want just the facts, so eliminate any off-topic information. Ditch extra bits and tangents. If you're teaching us how to rebuild a car engine, we don't need to hear the production history of the Mustang. Just give us directions.
- **Check your word count:** Example 1 from above has 76 words. Our revised paragraph comes in at 37 words. Saying the same thing in half the words is a great goal.



**Pro tip:** Concision reduces as many words as possible without changing the meaning.

## How to make sentences more concise

**Short sentences are your friend:** Writers eager to appear smart often use really, really, very quite long sentences. Pro tip: Don't do it. Overly long sentences are confusing. Aim for sentences that have no more than 24 words. Yeah, we know—sometimes your product name is longer than that. But do your best. Your paragraph will flow better with a healthy mix of sentence lengths.

Here's a long sentence from a backhoe manual:

“ Assemble small 90° adapter fitting to outlet port of filter base and orient so that free end of fitting will point toward backhoe and angled about 30° upward from horizontal. ”

Now, here's our revision with three short sentences instead of one long one:

“ Attach the small 90° adapter fitting to the port of the filter base. The free end of the fitting should point toward the backhoe. Angle the fitting about 30° upward of horizontal. ”

**Dump any empty words:** Empty words just sit there, like a lump on a long-winded log. Take a look back at the warranty example. The warranty used the phrase “In the event that.” But “in the event that” is just a fancy way of saying “if.” Why use four words when one will do?

**Reduce the amount of “to be” verbs:** “To be” verbs laze about without actually doing much. Of course, don't go overboard and weed every single one out of your verb population. Some sentences require “to be” verbs—no way around it. But, where you have a choice, replace lazy verbs with active verbs—ones that move the sentence forward. Fun fact: This paragraph contains no “to be” verbs.





Here's an example from a car assembly manual: "If you damage any parts, it will probably **be** because they **were** either not stored properly or, the wrong tool **was** used to install them."

That's three passive verbs in the same sentence. We eliminated the lazy verbs for our revision: "Storing a tool improperly or using the wrong installation tools can lead to damaged parts."

**Use passive voice strategically:** Using passive voice doesn't make you a bad person, no matter what your English teacher said in 10th grade. Just use passives purposefully. Unless you have a reason for using passive voice, switch to active voice.

Here's an example of passive voice from a user manual: "A booster seat should be **used** to obtain proper seat belt fit."

Who is obtaining the proper fit? Who is doing the using? That's the thing about passive voice: No one knows. Sentence construction isn't an episode of *Murder She Wrote*. No one should have to guess who did what. If you're writing directions, start with a verb.

Let's try rewriting that using active voice: "**Use** a booster seat to properly fit **the child's** seat belt."



## CHAPTER 3

## Crystal clarity

Imagine your words are a sliding glass door. Now imagine smashing into the glass door—hard. That’s how clear your writing should be: dangerously clear.

---

### Avoiding confusion: A commonsense approach

Check out this product description:

“ Work has been proceeding in order to bring perfection to the crudely conceived idea of a machine that would not only supply inverse reactive current for use in unilateral phase detractors, but would also be capable of automatically synchronizing cardinal grammeters. Such a machine is the Turbo-Encabulator. ”

Did you get that? Yeah, we didn’t either.

The Turbo-Encabulator is completely made up. But, when a description of the Turbo-Encabulator ran as a joke in a 1946 edition of *Time*, most people thought it was real. Why? Because they’d seen so many other bad manuals and product descriptions like it before. The Turbo-Encabulator is a parody of technical writing and, as with all parodies, it’s funny because it’s based on reality.

This, on the other hand, is 100% bonafide:

“ The delay knob moves the main sweep horizontally, and it pauses at 0.00s, mimicking a mechanical detent. At the top of the graticule is a solid triangle symbol and an open triangle symbol. The symbol indicates the trigger point and it moves with the Delay time knob. The symbol indicates the time reference point and is also where the zoom-in/zoom-out is referenced. ”

Granted, this oscilloscope operator’s manual isn’t designed for a novice. But the writers unnecessarily mention a “mechanical detent” and a needless passive sentence “is referenced.” It just makes the sentence hard to understand.

So, how do you avoid confusing your reader? Keep in mind that real people will read your writing, and they probably aren’t as technically knowledgeable as you are. Here are a couple of suggestions to make your writing more humane:

**Use plain language:** Did you know that Plain Language is a movement? Plain language “is focused on readers.” It ensures that your readers can “quickly and easily find what they need, understand what they need, and act appropriately on that understanding.” Use plain English, words that most people understand, and short sentences.

**Lay off the jargon:** Or, something surprising while reading at least, use it as sparingly as possible. Jargon is only used within a specific discipline. Chances are, no one outside of your industry knows what it means. If you absolutely need jargon, do your best to provide context, short definitions, or even a glossary of terms. Sometimes, jargon just makes you sound silly. Case in point:

#### **Extra-Lift Carriage Control Lever**

Brings small items close to the top of the toaster, for easy removal.

An Extra-Lift Carriage Control Lever? For easy toast removal, you say? Good for you... but the rest of us just call that a “lever.”

**Don’t turn verbs into nouns:** Verbs are happy being verbs. Don’t force them to become nouns when they don’t want to be nouns. Verby nouns makes your sentences unhappy, which in turn makes your readers unhappy.

Here are some completely unparsable work instructions for an automotive assembly line:

#### **With the control levers (handles) fully depressed:**

for the clutch—complete disengagement of the engine from the transmission; smooth shifting of gears means correct adjustment of the clutch cable.

---

**Simplicity can be striking.** We learned something surprising reading *On Writing Well* by William Zinsser: “Of the 701 words in Lincoln’s Second Inaugural Address, a marvel of economy in itself, 505 are words of one syllable and 122 are words of two syllables.”

---

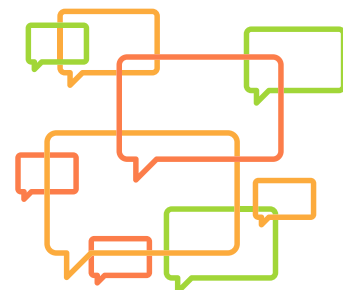

Now, we're not sure what's happening with the punctuation—and we'll likely never sort it out. But the nounification of those verbs, we can rectify. Here's how we did it:

Completely disengage the engine from the transmission. Correctly adjust the clutch cable for smooth shifting gears.



**Articles are not the enemy:** Articles are those little words in front of nouns, like “the,” “an,” and “a.” When writing instructions, people have a tendency to skip articles altogether. They say things like, “Disconnect cord from wall” instead of “Disconnect the cord from the wall.” We have yet to suss out the reason for this omission, but we assume that it is rooted in a deep-seated desire to sound like a robot. Until the singularity strikes, feel free to use articles whenever they are called for.

**Turn it over to a novice:** Sometimes it can be hard to tell when your writing is unclear. Want to make sure? Give your writing to someone who knows nothing about the subject matter. Try a Hallway Usability Test: hand what you're working on to five

random people who just happen to walk down the hall. Every time someone says, “I don't know what this means,” you've gone off the rails on the clarity train.

iFixit's original field service manuals were tested on unsuspecting art students: we handed them a computer and our new manual and watched them use the instructions to take it apart. Every time they got confused, we knew we had a problem. We used what we learned from their attempts to make the service manual better.

**Don't use weasel words:** Some words weasel into your sentence and steal your oomph. Words like “quite,” “mostly,” “slightly,” “seems,” “sort of,” “pretty,” and “somewhat” are built-in sentence loopholes. They signal to the reader that you mean what you say ... just not really. Is the screw “pretty hard to tighten” or is it just hard to tighten? Is running into your ex “fairly uncomfortable” or is it just downright uncomfortable? Say what you mean without wishy-washy words.



## CHAPTER 4

## Communicate with style

Manuals aren't pulp fiction page turners. But that doesn't mean they have to be a snooze-fest. Instructions are important. People need them. As writers, it's our job to make reading manuals not feel like a chore. Write with style.

---

Style doesn't necessarily equate to poetic language and intense imagery. Every writer, no matter how technical the material, has a style. Style is how you, as an author, choose to communicate with your audience. It includes things like tone, humor, and the degree of formality in your writing. Good style is about making decisions—about knowing what to include and what to omit, when to follow the rules and when to break them.

You can break all the rules that we've listed, but you should do so for a clear reason. For example, in Chapter 2 we told you to be direct and avoid tangents, but sometimes the best way to explain a feature is to include an anecdote. In that specific moment, it's fine to break that rule. The benefit of storytelling outweighs the perks of being concise. Just don't go around breaking rules without good reasons for doing so.

Mackie's user guides are an inspiration. Mackie's style is instantly recognizable. They know their audience—professional sound engineers—and how to reach them. They address their readers like friends, while still passing on detailed instructions and expert-level knowledge.

---

**It's okay to write informally**—but that degree of informality should vary depending on subject matter. If you're writing maintenance procedures for a nuclear power plant, it's probably best to stick to a formal, business-like tone. If you're writing instructions on how to build a backyard barbecue, feel free to write in a style that is friendly and informal.

---

Here are some style highlights of Mackie's style:



### Humorous instructions:

“ Pack yourself a big lunch and go for a nice walk outside. Have a picnic and lie back and dream. Things are going to be so good now. ”



### Realism:

“ This icon will lead you to some explanations of features and practical tips. Go ahead and skip these if you need to leave the room in a hurry. ”

### Anecdotes:

“ The dual-purpose mute/alt 3-4 switch is a Mackie signature. When Greg was designing our first product, he had to include a mute switch for each channel. Mute switches do just what they sound like they do. They turn off the signal by “routing” it into oblivion. “Gee, what a waste,” he reasoned. “Why not have the mute button route the signal somewhere useful, like a separate stereo bus?”

So mute/alt 3-4 really serves two functions—muting (often used during mixdown or live shows), and signal routing (for multitrack and live work) where it acts as an extra stereo bus. ”

## Want to develop your own distinctive style?

### Here are a few considerations:

**Humor:** Everyone likes humor. Apply with extreme care, however. Humor and wit is almost impossible to capture in translation, so only use it if you're writing for a local audience. After all, what's funny in the U.S. might not be funny in Iceland, or Turkmenistan, or Japan. Plus, humor is hard to get right. It takes writing, rewriting, whittling, and gumption. And sometimes, it's not appropriate—don't use it in precautions, and not in anything that may have legal ramifications. Also, sarcasm may sound funny in your head, but it usually just comes off as mean.

Despite the drawbacks, humor is sometimes the most memorable way to make a point. You can talk about capacitors until you're blue in the face, but make people laugh and they'll remember it.

### Some tips on writing funny:

- Only write it down if it makes you laugh.
- Erase the funny part and write it better.
- Stop trying to be funny. Funny works best when it's spontaneous.
- Don't be mean to real people. The only actual person you're allowed to make fun of is yourself.
- Read something hilarious before you write. We recommend Dave Barry, funnyman journalist extraordinaire.
- Humorist Sherman Alexie suggests, "Write naked—that will make you laugh." Don't ever try this in the office. It's still hilarious, but you'll probably get fired.

**Set the tone:** Your writing can be serious, authoritative, journalistic, friendly, humorous, or anything else you'd like. As a writer, you dictate the tone. But don't change halfway through your document. Find one you like and stick with it.

**Addressing the audience:** The classic writing conundrum: Can a writer say "you" when referring to the audience? Sometimes people avoid the second-person pronoun to achieve a sense of distance and impartiality—especially on scientific topics. But if you are telling readers what to do, "you" and "your" is perfectly acceptable. In fact, when used purposefully, the informal "you" sounds more natural and encouraging.

**Ex:** "How to upload images onto your computer" vs. "Uploading images to a computer."

**Ex:** "Be careful when you pull the wire from its connector" vs. "The wire should be pulled from the connector carefully."

Ultimately, the choice is up to you.

**Using contractions:** To use contractions or not to use contractions? That's the question. We have the answer: 'Tis nobler to use them. Contractions shorten your sentences and improve the overall flow. If you doubt us on this point, try reading a paragraph without contractions aloud. It sounds unnatural. Swap in contractions and the paragraph sounds human again.

---

**Something to consider:** If you plan to translate your manual into another language, using a lot of contractions can make the job more difficult.

---

**Short paragraphs are key:** The rule of a well-formed, five-sentence paragraph is suspended in tech writing. You don't need theses or topic sentences for manuals, and you don't need long paragraphs to defend your assertions.

You can start a new paragraph whenever you start a new thought. (See what we did there?) Readers like short paragraphs. Short is easier to skim. We're fans of using short, declarative bullets to break up content into little readable chunks.

**Internationalization:** If you plan on publishing for an international audience, your manual will need to be translated, which is an expensive process. The right style will make the translation process much easier. Some general style tips are the same: It's even more important to limit your vocabulary to simple/common words. But when writing for translation, avoid jokes and idioms (they don't translate well), use contractions in moderation, and be consistent with your phrasing. This tutorial, for example, would be very hard to translate into another language. We've used a lot of colloquialisms and idioms, quite a bit of creative language, and we didn't bother to limit our vocabulary. That's a decision we made to keep this (long) tutorial both informational and engaging. These are the kinds of tradeoffs you'll have to make as a writer.





## CHAPTER 5

## Know your audience

Writing never takes place in a vacuum (unless you're literally in a vacuum, which would be incredibly uncomfortable). When you're writing a manual, you're always writing to someone. Figure out who that is. The more you know about them, the better your writing will be.

---

Optimize your manual to match the target audience's expertise. The Books for Dummies series, for example, has successfully targeted one narrow audience: the clueless newbie. For Dummies publishers have a book on everything from writing résumés to coaching children. Each one features diagrams, illustrations, extended explanations, context, and basic tips.

Auto Repair for Dummies has a whole chapter dedicated to changing your car's oil. It covers what oil does in the car, the pros and cons of synthetic oil, and instructions—15 pages of 'em. If the book was entitled Auto Repair for Experts, however, that whole chapter could be boiled down to a single sentence: "Change the oil." Unless they're changing the oil on a supercar, no car expert will need 15 pages of instruction for an oil change.

Knowing your audience means knowing what to include and what not to include. It means you know how many steps it'll take to explain something to them. It means you know how long your manual is going to be and what sort of language you can get away with using.

Here are a few things to keep in mind:

### Reading level = writing level

You shouldn't write over your audience's head. You also shouldn't write drastically under it, although in our experience this is rare.

---

The average American adult reads at about a ninth-grade level.

---

Flesch-Kincaid Readability Tests are the most common way to ascertain a text's readability. Flesch-Kincaid scores ease of reading on a scale of 0-100, with 100 being the easiest to read. Another Flesch-Kincaid test estimates reading level (K-12).

To show you just how wide manuals can miss the mark, we decided to test a manufacturer manual for a popular product—Apple's MacBook Pro—on the Flesch-Kincaid scale. The Apple user manual scored an abysmal –2.2 and required a reading grade level of 24. (In case you were wondering: no, grades don't go that high.) To put this in context, Shakespeare's *Macbeth* is at an 11th grade reading level.

Here's a safe rule of thumb: A user manual shouldn't be more difficult to read than Shakespeare.



iFixit's repair manual for the same device scored at a fourth grade reading level. The lower the reading level, the more likely your readers will be able to understand what you're saying.

Not sure how to gauge the reading level of your writing? You can use sites like The Readability Test Tool to measure readability on existing web sites. Word and Excel already have readability tools built into them—they just need enabling.

## Existing knowledge

What can you assume your audience already knows? Technical writers often forget what their audience knows and, especially, what they don't. Mechanical engineers sometimes write manuals that sound like they are written for other mechanical engineers—but if the target audience isn't super tech savvy, then rambling on about shear load, helical gearing, and kinematic chains without an explanation is a problem.

Military organizations are amazingly bad at this. They have so many acronyms that you have to spend months learning them all before you can communicate with anyone. Here's an example from an Army Shipboard Operations manual:

- a. Emergency Training. Emergency requirements or training necessary for imminent deployment usually will come from DA through a MACOM such as FORSCOM. Army aviation units will receive the higher command's assistance in scheduling ships and other resources.

The standard practice in technical writing is to spell out an acronym on its first usage, putting the acronym in parentheses. This ensures clarity for all readers.



## CHAPTER 6

## Photograph the process

They say a picture is worth a thousand words. They're right. Don't just tell readers how to do something—show them.

---

Historically, photos haven't gotten much love in manuals—even in service manuals where photos might be the difference between poorly installed brakes and a car that stops when told. The holy grail of standardization, ISO 9001 documentation, is usually text only. Given the historical expense of printing costs, this made sense. But that was then, and this is now. Welcome to the digital revolution: the world is your high-resolution oyster.



iFixit teaches people how to repair their electronics. That's dicey business. After all, there are tons of little components and little connectors in any given device. Take Zero-Insertion Force (ZIF) connectors, for example. Not only are they tiny, but they're equipped with even tinier, delicate flaps that have to be pried up and flipped over. Do it the wrong way—a common mistake made by newbie technicians—and you could break the entire device. Those are some pretty high stakes.

Here are iFixit's text instructions for freeing the ZIF battery connector in an iPod Nano:

“ Hold down the light-colored socket with your finger. Then use the tip of a spudger to flip the ZIF cable lock 90° upwards. ”

And while those are good instructions, they aren't enough. There's too much room for error. So, iFixit includes high-resolution, color photos with every single step. That way, you can zoom in and figure out exactly what the component looks like, where the flap is, and how to pry it up. Photos like this one have saved the life of many a ZIF connector:

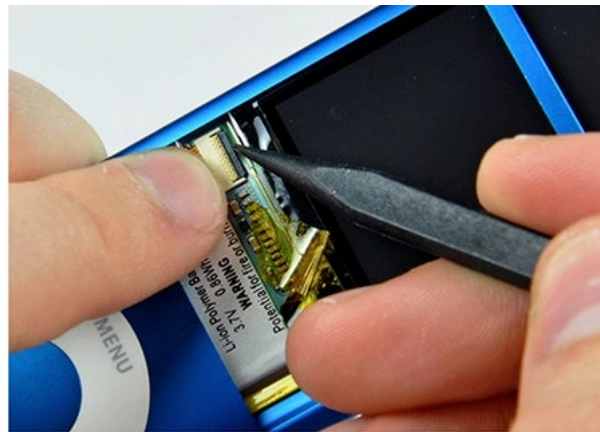

Photography brings instructions to life. It makes things more clear. Compare an Ikea manual to iFixit's self-repair guides. Depending on the level of clarity, repairing your iPhone can be more accessible than assembling a set of cupboards. That's the power of photography.

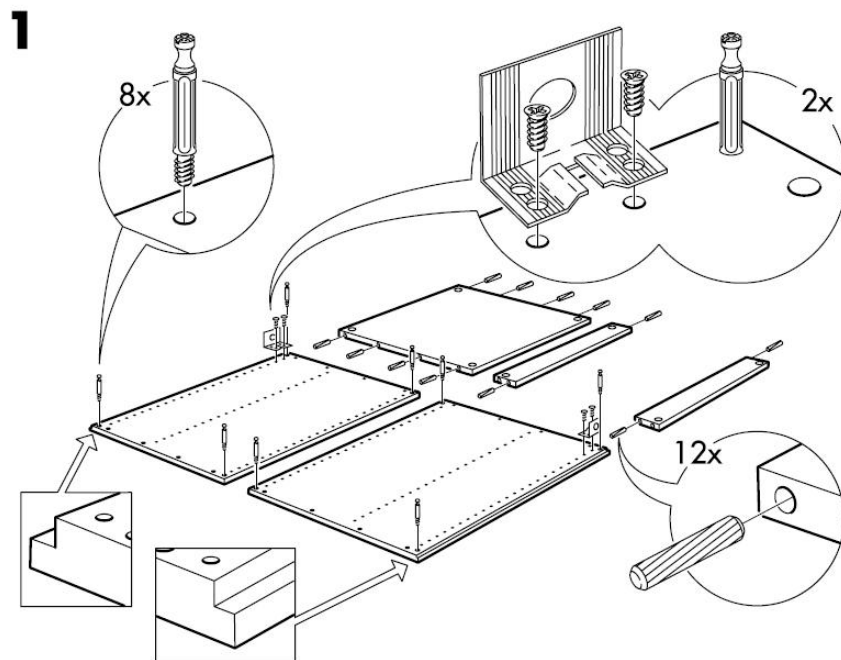

## Tips for photography



Not a photography expert? Not to worry! Modern cameras make it surprisingly easy—and fast—to take useful photos. Our tips and tutorials will have you shooting like a pro in a flash.

## Setting up the photoshoot

The most important component for taking pictures is choosing the right camera. We highly recommended that you use a digital single lens reflex (DSLR) camera to take professional-quality guide images. If you don't have a DSLR camera, any point-and-shoot camera with at least 6 megapixels will capture images with sufficient resolution.

---

**Our company**, Dozuki, helps companies create step-by-step procedures for service manuals, industrial work instructions, and more.

---



No matter what camera you decide to use, every hand-held camera is prone to shakes and vibrations that cause blurry photos. Using a tripod, even a cheap one, keeps your images sharp.

The better your lighting is, the less you have to post-process the photo. Unfortunately, your old bedside lamp just won't cut it. Despair not! You can construct a relatively inexpensive DIY photography studio out of simple light fixtures, the right bulbs, and a clean, white surface.

If you're investing in a professional lighting setup, a proper photographic light fixture should house three or four individual light bulbs. To cut down on harsh glare, slip a diffuser over the front of each fixture.



## Taking the perfect photo



- **Aperture and ISO:** Understanding aperture and ISO will help you take professional-level photographs. The aperture setting changes the amount of light that comes through your lens; folks commonly refer to it as “f-stop.” The ISO setting changes the sensitivity of the camera sensor at the expense of image graininess. We explain both in much greater detail in our tutorial, so use it to practice, practice, practice by taking sample photos \*before\* you start documenting your procedure.
- **Shutter speed:** Just pressing the shutter button can cause a camera to shake—producing blurry images. Blurriness is unacceptable. Use a remote shutter release, camera tethering software like Nikon Capture.



- **Framing:** When taking photos for your manual, place whatever you're doing in the center of the frame and from your user's point of view.
- **Close up:** Zoom in to get detailed shots of specific actions, especially when performing smaller or more intricate tasks. But be careful that the viewer doesn't lose context—provide an intermediate view in addition to the über-zoomed shot.

## Using your hands

If you are documenting instructions, we recommend that your images include hands whenever possible. Hands are great at demonstrating the actions described in each step. And not drawings of hands—actual hands attached to actual people performing the actual tasks that users actually want to do. User manuals that feature photos of hands working on intricate components give users a better idea of how to replicate the desired action.

iFixit manuals have trained millions of novices in the craft of electronics repair by using step-by-step high-res, color photos of hands demonstrating the process. Seeing those pictures makes it easy for users to repeat the same process on their own.

---

**Pro tip:** Don't cover up the action with your hands. Sometimes this means holding an item or tool differently than you normally would. It may feel awkward, but the resulting image will show the action much more clearly. The second image demonstrates an overhand knot much more efficiently than the first image does.

---



## Processing your photos

- **Programs:** Pictures rarely come out perfect and will require some editing to make them usable for manuals. There are many photo editing programs, like Photoshop (\$) and Gimp (free), available. Learn a decent one and start editing your photos.
- **Color and exposure:** When editing, adjust the light levels to balance whites and blacks properly. Adjust color hues and saturation to correct color errors in the background.
- **Editing:** Not all work environments are perfectly clean, so subjects may end up with hair, dust, dirt or other imperfections on them. Remove blemishes, if possible, with a little editing magic.
- **Markup:** When using photography, We suggest using markup to highlight certain areas of the photograph, like in the example below (Dozuki already has a built-in markup system). Multi-colored boxes and circles are great for highlighting areas you want readers paying attention to. The markup colors below have been chosen so that the color-impaired can differentiate between them.







## CHAPTER 7

## Use visuals

Videos, illustrations, diagrams and graphs work wonders when you want to explain exactly how something works and how to assemble or fix it. Even better, visuals allow you to be more concise.

### Diagrams and illustrations

Diagrams and illustrations are a great way to give readers a big picture layout of devices, parts, and components. The more visuals you include, the fewer words you have to use. They are also especially good at breaking down hard-to-see or hidden elements, like the wiring schematic of a car.

Here's an example diagram from a Mackie Onyx Analog Mixer, an extremely complex machine with lots of hookups, plugs, and doodads. This great diagram clearly shows what those plugs do:

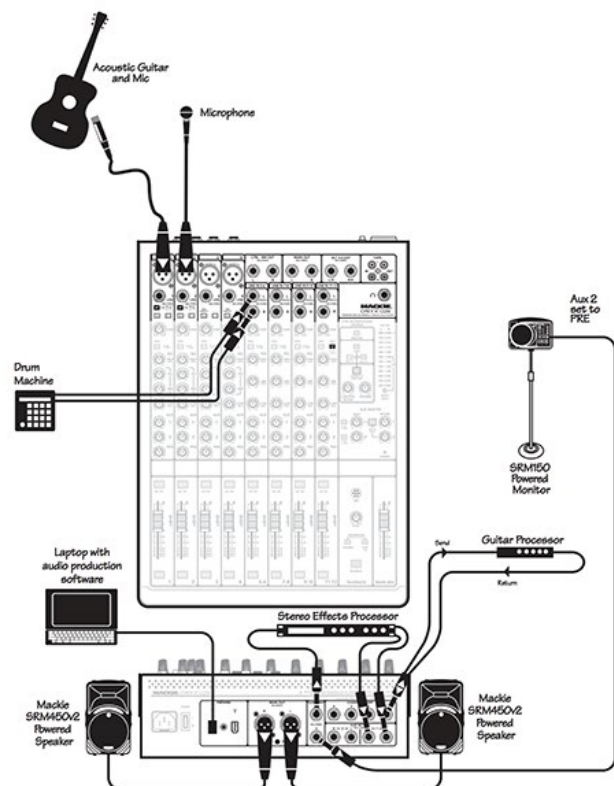

Use images only when they support, replace, or augment the text.

Mackie diagrams are amazing. But in our experience, bad diagrams outnumber the good ones. Most of the time, diagrams fall short because they are not descriptive enough. Others are poorly rendered, too cluttered, or not augmented with enough written explanations. Imagine trying to put something together when the diagram looks like this:

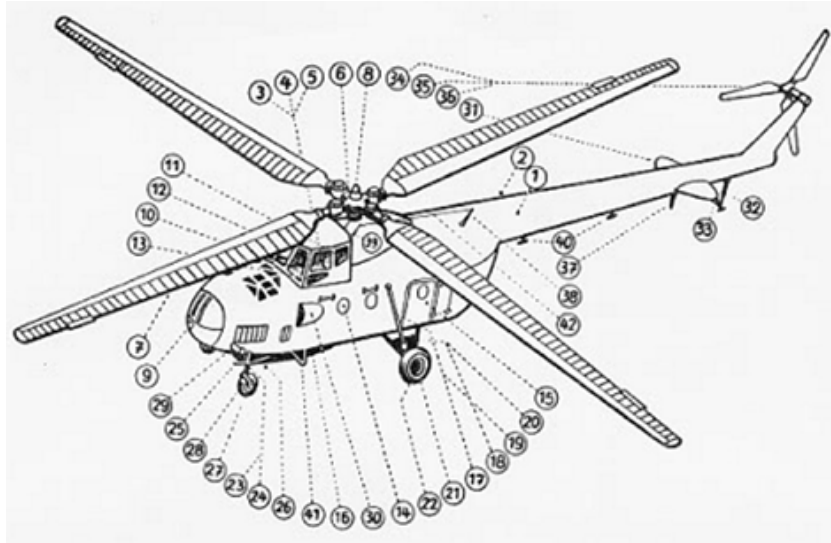

Or, how about this?

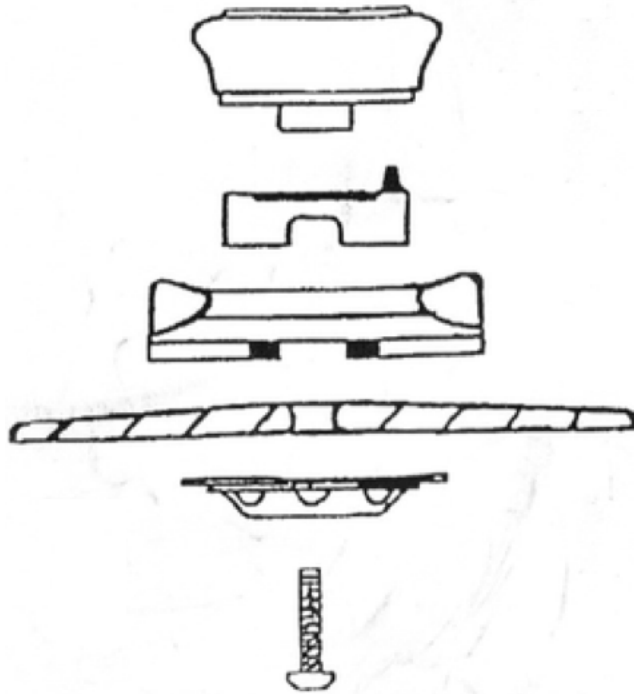

When you're in the midst of a complicated repair or installation job, bad diagrams won't be helpful.

## Video instructions

The only thing people love more than a picture is a moving picture. If you are publishing digitally, you can embed videos directly into your manuals.

---

If you're internationalizing your manuals, avoid using text in diagrams or overlaying text on photos—otherwise you'll need to produce separate versions of each image for every locale.

---

People are drawn to instructional videos. They mimic that one-on-one, expert/apprentice relationship that we all crave when learning something for the first time. Video instructions are so popular that YouTube has now become the internet's default how-to authority for everything from computer repair to equipment setup to physics. A search for “how to” on YouTube's video archives returns over 19 million hits. A single YouTube tutorial on how to fold a t-shirt in under 2 seconds has been viewed millions of times.

Videos can make learning easy, but—big warning—they are also easy to overuse or mess up. If your reader is looking for specific information, videos can be frustrating. No one wants to watch a 20-minute video when they're only interested in locating a screw.

Weigh your options before you make video instructions your primary source of documentation. Most of the time, a single photograph or an amazing diagram will be more functional at identifying connectors, parts, and processes. And, unlike videos, photographs can do it at a single glance. Only use video when other visuals won't cut it.

## Use videos when...

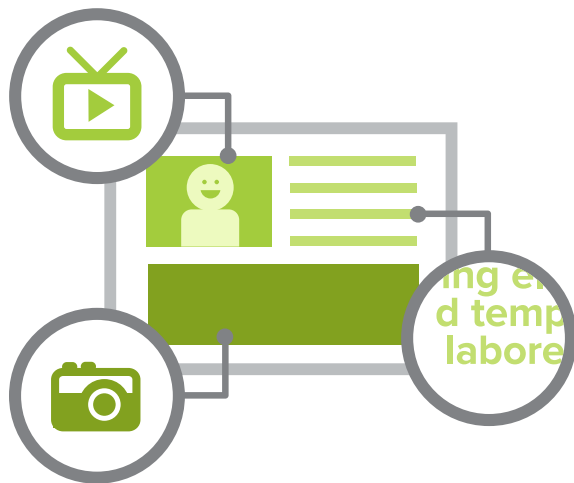

- Demonstrating rotation procedures, like how to turn an out-of-the-way valve.
- Demonstrating involved actions, like threading a sewing machine, picking a lock, or tying a knot.
- Demonstrating states that do not translate via photography or text, like testing if the custard you're making is “jiggly” enough, identifying which clanking sound an engine is making, or determining if the concrete you're mixing is thick enough.
- Demonstrating how much force to use, like how hard you have to pull on an iMac cover before it actually pops off.

If you've decided that video guides are the way to go, then apply the rules of writing to the editing room. Video guides should be concise, demonstrative, and clear.

We've filmed a lot video guides that can stand alone, but we've found that the most effective way to use videos is to embed them directly into online, step-by-step guides. Short video clips work very well alongside diagrams, photographs, and text to augment procedural instructions.

### Frequent problems with video instructions...

- ✗ **Problem:** Translating audio requires an additional workflow while localizing manuals.
- ✓ **Solution:** Video without verbal instructions.
- ✗ **Problem:** Updating videos for new manual revisions is more inconvenient and expensive than updating photos and text.
- ✓ **Solution:** Use videos judiciously, avoid faces that may not be available for future videos, and keep the original video project files in your version control system.
- ✗ **Problem:** Scanning videos for specific information is slower than scanning text and photos.
- ✓ **Solution:** Keep videos short and the information specific and targeted.
- ✗ **Problem:** You can't search for information inside videos.
- ✓ **Solution:** Subtitle videos and make the text searchable, or replicate the information in the text.
- ✗ **Problem:** Manuals sometimes need to be printed. Photos degrade gracefully even when you're printing in black & white, but video information is lost altogether.
- ✓ **Solution:** Use other visuals unless videos are strictly necessary. Choose a useful poster (thumbnail) image.

Here's our rule of thumb: in-manual videos should be no longer than 30 seconds per step. Sometimes just 3 seconds of video is enough to get the job done. The shorter the video, the better.



---

With Dozuki, you can integrate warning symbols into the necessary step. But even without Dozuki, you're not flying blind. The International Organization for Standardization (ISO) has a standard, international set of warning and safety icons, while the American National Standards Institute (ANSI) publishes safety standards for the United States. Consult both organizations' standards if you are publishing internationally.

---

## Icons and symbols

The first rule of any profession is to do no harm (especially since doing harm opens a company up to litigation, as we discuss in Chapter 9). So, make your best effort not to set people on fire or expose them to electrical shock.

Where harm is possible, say so. But here's the rub: since most readers skim, you need more than bold lettering to grab a reader's attention. That's where icons and symbols come in handy.

Some manuals, like the For Dummies series, include 12 different icons that readers need to remember. No one will ever hold that many symbols in their head. Don't use a dozen symbols when just a handful will do. We recommend, at the very least, using "Note," "Caution," and "Warning" as safety designations. Not all icons translate. So, be sure to use universally accepted icons, like a splat symbol, or those published by ISO or ANSI.



## CHAPTER 8

## Organize your content

There is no single correct way to organize a manual. The manual you create should reflect whatever product or process you're writing about. Here are some common sense solutions to organizational conundrums we've run into.

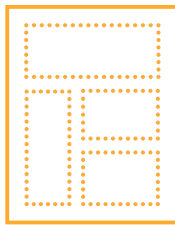

### Always outline

Outlines are a necessary part of writing. Period. Outlines are like a roadmap. They give you direction; they tell you where to go. Working without an outline is like trying to get from California to New York and only knowing you need to go east.

### Put yourself in the place of the audience

Try to imagine things from your target audience's point of view. Anticipate where your audience might have questions or how they might logically approach a task. Organize accordingly.



### Be task-oriented

People read manuals because they are trying to figure out how to do something. Organize the body of your manual by activity, like “Quick Startup Guide,” “Troubleshooting,” “Replacing the Ignition Switch,” or “Using your Samurai Sword for Zombie Defense”—whatever task you think your reader might be interested in accomplishing.

## Use lists

People love lists. On the internet, lists are almost as popular as cats. Unfortunately, we've yet to find a legitimate way for non-veterinarians to integrate cats into technical documentation (oh, we've tried). Lists, though, are a go. Whether numbered or bulleted, short lists are easy to understand and highly skimmable.

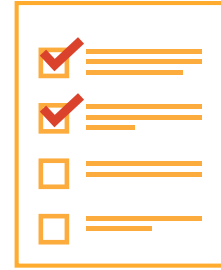

Not sure what sort of sections or subsections might be appropriate for your manual? There are lots of ready-made templates available on the internet. Reference them, but resist the urge to use them completely. Design your own structure. Take a look around at other manuals in a similar genre. Figure out what you like and what you don't like about them. Use that information to make your manual better.

## Writing useful instructions



We've been writing instruction manuals for years. One of the toughest lessons we've learned is that great instructions don't happen on the first try. They come after trial-and-error, experimenting, and rewriting.

Sometimes, readers fail in ways that you can never anticipate. We learned that one the hard way. On a PowerBook G4, the optical drive connector is extremely hard to see. Our writers had a hard time explaining how to get the drive off without breaking the connector. When we published the guide online, someone used the guide and our instructions broke his computer.

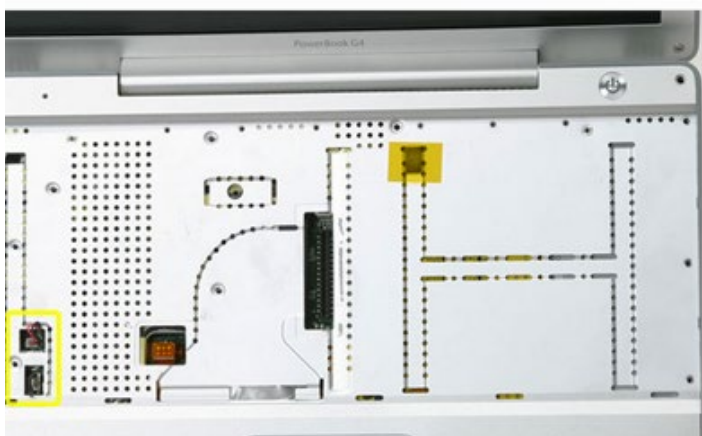
After we apologized profusely, we rewrote the guide. And then we rewrote it again. And again. Until it was perfect. Here's the final version of the rewritten text:



**Step 17** [Edit](#) 

- This step is extremely tricky, and has the potential to ruin your computer. It is easy to pull the plug with the red and black leads (the power) out of the motherboard. If you do that, it is nearly impossible to fix. 
- Peel up the two pieces of foil tape on the left side of the keyboard area.
- The connectors at the ends of the cables are attached very firmly to the sockets on the logic board. Pulling directly on the cable will either separate the cable from its connector or the socket from the logic board. 
- Carefully disconnect the microphone and power cables from the logic board. Using your fingernails or a dental pick, carefully pry the connectors from their sockets. Make sure you're pulling only on the connector and not on the socket.

We learned from that experience. Now, we don't wait until people break their stuff to rewrite our instructions. We solicit feedback from our users right away. When we released repair kits for Xboxes and PS3s, we asked purchasers to give us feedback on the instructions. Then we

used their feedback to rewrite our guides. We've also integrated a comment feature in our guides, so users can share with each other where they ran into trouble and how they overcame the obstacle.

Find some way to get feedback on your instructions. You don't need a web site to do it. Being on the receiving end of negative feedback is one of the toughest things you can do—but it is also the most important thing you'll do for your writing. Bribe friends and coworkers for feedback, if you need to. Cookies, alcohol, or promises of babysitting—whatever it takes.

Making this feedback public can be surprisingly productive. Our readers tell us that the comments on iFixit manuals are often just as useful as the instructions themselves.

## Organization

The nice thing about writing instructions is that they're easy to organize. Just arrange things in the order they need to be done. We've found that step-by-step instructions with high-resolution pictures, diagrams, and videos are the most effective way to design instructions. Bulky paragraphs aren't necessary if you let visuals do most of the talking.

When it comes to instructions, an ounce of preparation prevents a pound of frustration. Here are some great things to tell your readers before they start working:

- **Difficulty level:** Novices should go into a procedure knowing how hard it's going to be.
- **Time required:** No one likes to figure out four hours into a task that it's going to take four more hours. Especially if they needed it done 30 minutes ago. Make sure the estimated time takes into account the time involved for any prerequisite disassembly. If you're an expert and you're writing for a novice audience, assume it'll take them anywhere between 20-50% longer to perform the same task. Account for that discrepancy in your time estimates.
- **Materials required:** If tools, parts, and materials are required, list them up-front.

## Intelligent content reuse



When you're writing a lot of instructions for a single device or machine (or lots of similar devices), reusing content saves a lot of time, work, and space.

Complicated tasks require a lot of dependent procedures. For example, whether you are changing the brake pads on your car or rotating tires, both tasks require you to remove the wheels first. We like to call dependent tasks—like removing the wheels—prerequisites, because completing the procedure is required before you can complete the whole task.



Reuse prerequisite tasks instead of rewriting them every time they appear in a manual. Most print manuals put prerequisite guides in a single place and ask readers to flip back and forth between the sections. So, the prerequisites are listed as a step.

- **Step 1:** Put your right foot in.
- **Step 2:** Remove the wheels. See pg. 34.
- **Step 3:** Put your right foot out.

When you finish with the prerequisite task, you flip back to the original instructions and move on to step three—like a convoluted Choose Your Own Adventure book. Flipping back and forth between sections isn't terribly convenient, but that's the best you can do on paper. On fancy computers, however, you can do a whole lot better.

Don't treat computer manuals like print manuals. Doing so imposes unnecessary limitations on a far more advanced technology. Instead of asking readers to click back and forth through different web pages for prerequisites, integrate prerequisite guides directly into the tutorial. That way, all the instructions your readers need are on one web page.

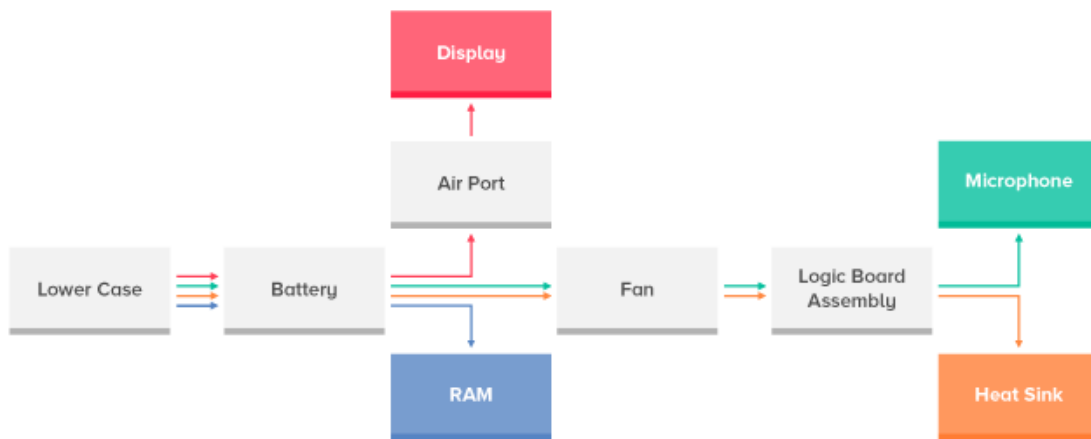

For example, here's an iFixit guide for removing a MacBook battery. The battery removal guide is a prerequisite for the RAM replacement guide for the same computer. You can see that the first two steps of the MacBook RAM guide are actually the steps for removing the battery. Instead of asking our users to click back and forth between individual procedures like you would in a printed book, the Dozuki software lets us list them all on the same page for a seamless user experience.

Many publishing platforms allow you to intelligently reuse content, labeling some procedures as prerequisites for automatic insertion into the instructions that require them.



## CHAPTER 9

## Legal requirements

Thus far, this handbook has covered topics that are nice to include, but there are a couple of things you must include in your manual.

---

Documentation should prepare readers to safely use the product. US law stipulates that a manual must list any hazards that may occur “from the intended or unintended but reasonably foreseeable use of its products.” You have a legal duty to warn consumers when:

1. The product supplied is dangerous
2. The danger is or should be known by the manufacturer
3. The danger is present when the product is used in the usual and expected manner
4. The danger is not obvious or well known to the user

Failure to “adequately” warn consumers opens your company up to lawsuits. So, what exactly makes a warning “adequate”? Good question. Adequacy is almost impossible to define. It’s much easier to define what is not adequate. Here’s a few common ways that manuals fall short:

- Failure to warn users about how to properly use a product.
- Failure to warn against risks from proper use of a product.
- Failure to warn against any reasonably foreseeable misuses of a product.

The key commonality is that everything listed could result in bodily harm or death.

Safety information must also be accessible to your readers. So, warnings should stand out from the rest of the documents, possibly with icons, colored fonts, or bolding. They should

also be easy to understand. A confusing warning is just as bad as not warning users at all.

Many companies list warnings at the beginning of the manual to give them prominence. That's fine, but also list hazards where the reader might encounter them in your instructions.

Of course, it's tempting to frontload your manual with pages and pages of warnings as a preemptive strike against lawsuits. Lots of companies do it. Every electronic product is dangerous if you stick your tongue in the socket along with the plug. Just be reasonable. We've seen warnings that border on the bizarre: "Do not eat your iPod Shuffle"; "Do not use your hairdryer while sleeping"; "Do not use this rotary drill as a home dentistry kit," etc.

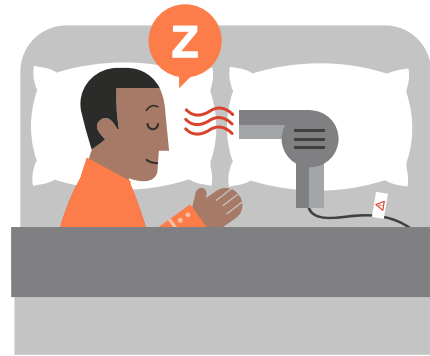

Before you brainstorm a list of improbable-but-possible warnings, we've got a warning of our own: Too many warnings—especially ridiculous ones—make the whole safety section seem silly. Then, no one takes the warnings seriously—not even the real ones. Remember: You only have to caution users when a danger is “reasonably foreseeable.” Aim for the Goldilocks principle: find the middle ground between not enough warnings and way too many.

Liability laws vary by country. European liability regulations are decidedly strict, and Asian liability laws are starting to follow suit. If you plan on selling your wares internationally, you will have to account for various regional liability requirements. Learn about liability concerns and relevant international product liabilities before you publish your manual. As always, consult a lawyer for specific information on how to construct warnings.





## CHAPTER 10

## How to publish

These days, you have a ton of choices for how to publish your manual. Print is the classic choice. PDFs are essentially a printed book in digital form, and are the default choice for most manuals today. PDFs get the job done, but are rapidly becoming obsolete as people move to consuming manuals on mobile devices.

---

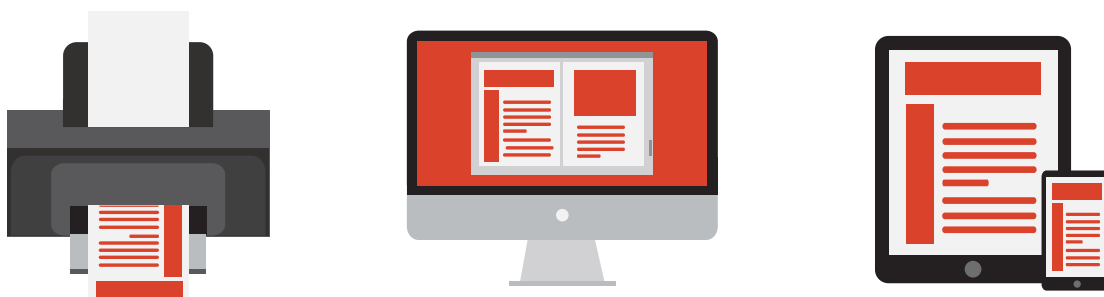

A lot of companies are evolving the manual with online publishing platforms. There are wikis, like this fanmade user's guide for SecondLife. Instead of the standard PDF, Sony created a custom, online instruction manual for the PlayStation 3. Many companies are deploying tablets onto the factory floor, replacing PDF work instructions with mobile documentation stations.

These days, everyone has a smartphone in his pocket and a tablet on her bedside table. Information is mobile—your manual should be, too. Optimize your manual for mobile devices. PDF manuals don't work well on phones. They're too dense, rooted in paper's legacy fixed-

width format, and difficult to search and navigate. They work better on tablets, but miss out on much of the advanced functionality that's now possible.

Information in your manual should also be easy to find, no matter how you choose to publish. Users hate flipping or scrolling through hundreds of pages to find the one sentence they want. So, if you're publishing on the web, integrate a kickbutt search feature. If you've written a hefty print manual, write a table of contents and an index.

Making your manual easy to browse on the web has another key advantage: it's available through Google. Most users google information before they go to the manufacturer's website. Google is the primary user interface for iFixit—most people find our instructions via web searches.

Make your manual easy to find on the web. Think about what potential users might type into their Google search boxes when they're troubleshooting, and use that language in your manual. Plan to adapt your manual in the future as people shift their search terms.

---

Check out iFixit's native mobile apps for Android and iOS if you need some inspiration. The software is open source, so you can even copy the code to build your own mobile manual.

---

Accessibility also means optimizing for different types of audiences. Done right, web manuals are very accessible to blind readers, and anyone can use a translation service to see a web manual in their home language. It's impossible to get the same sort of accessibility with a paper manual, and it's hard to do with a PDF.

## Getting better: Knowledge management

Publishing isn't the end of your job. Documentation needs to evolve. Make no bones about it: your manual will go out of date at some point—and often in ways you'd never expect.

- Sometimes, the writing itself is the problem. Hey, we're human and writing is hard. Every once in awhile, writers make mistakes. And when that happens, people start breaking things. That's okay. Version 1.0 of any product—software, hardware, or manual—is never perfect.
- You may find an easier way to approach a task. Maybe it's easier to use a flathead screwdriver than a Phillips; maybe there's this new tool that makes something incredibly easy; or maybe an assembly line worker found a faster way of assembling the product, etc.
- Other times, the product itself changes. The production line can change after the manual was written: they add screws, reconfigure the mold, or make other minor (or no-so-minor) changes.

Plan for the inevitable. If it's hard to publish changes, you'll be likely be less than eager to

update your documentation as frequently as you should.

If it's at all possible, we suggest a publication method you can easily update. Unfortunately, there is simply no easy way to update a paper manual. In an Air Brake and Train Signal Manual from 1910 (pictured below), the authors literally pasted updates directly over the outdated information. In 2012, Toyota had to recall thousands of cars because they botched a couple sentences in the manual.

Publishing a PDF doesn't offer much more flexibility. If you've released 1,000 PDF manuals

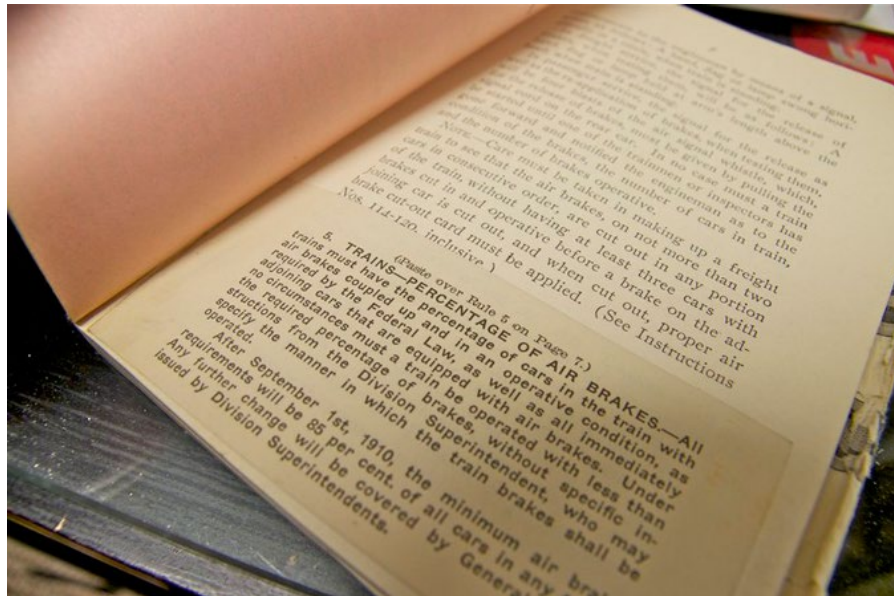

onto 1,000 laptops, you'll have to update all of them manually. No fun. And what happens if a safety-critical update misses 5% of your field technicians? That's just one reason we tend to advocate central data storage instead of the standard print/PDF workflow.

## Integrating feedback



You need your customers—not just to keep your business alive, but to also keep your content thriving. Your customers make you better. The more feedback you have, the more suggestions you get, and the better your documentation (and your company) will be.

Customers can point out where text is confusing; they can tell you when an image just isn't helpful. Recruit users to help you improve your manual. If you

publish online, give users a directed Q&A for feedback and editing suggestions. If you publish in print, give readers someone they can contact for questions and feedback.

## API means write once, publish everywhere

Google Maps is installed on millions of smart phones in America. Even though Google is constantly updating and expanding their maps, users always get the latest version of the app. How is that possible? Because the information people want isn't downloaded into their phones—and they don't have to re-download the application every time Google updates the map. The information lives elsewhere and constantly publishes updates to all connected devices. It's an API.

API stands for Application Programming

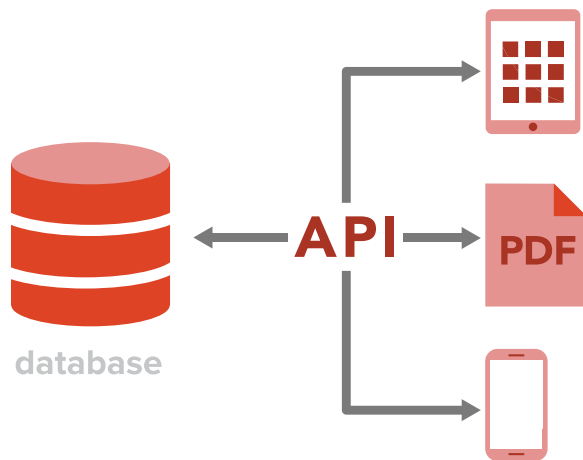

Interface: if you publish online, it will help you seamlessly update your documents. Traditionally, document updates are pushed through Word, maybe to inDesign, then PDF, then onto the web, to techs, and to the archives. And if you make a change to the text in Word, that change needs to make its way to every other format. By the time everyone has an updated copy, it's time to update again. Using an API allows you to make changes to one central hub. Those changes are then pushed out immediately to every single other publishing platform.

Modern documentation formats like oManual include API specifications, and documentation systems that support mobile apps are starting to take advantage of this.



## CHAPTER 11

## After you write

Creating your instructions is just the beginning. Once your first draft is done, it's time to test it in the field, edit for concision, deploy your work, listen to your users, and manage future updates.

---

### Editing

Edit, edit, edit. We cannot overemphasize the importance of this step. Edit for organization, content, flow, and grammar. It's important that your readers get a polished product. After all, when it comes to instructions and manuals, proofreading can be the difference between a snappy sentence and a disaster.

Take these two sentences: “The ultimate guide for summertime fun: grilling kids and family” and “The ultimate guide for summertime fun: grilling, kids, and family.”

That's right. The only thing standing between you and cannibalism are a handful of commas. That's why we edit and proofread over and over again. Then, when we think it's perfect, we get other people to edit it, too.

Read your manual aloud to yourself. You'll find errors if you can listen to it.

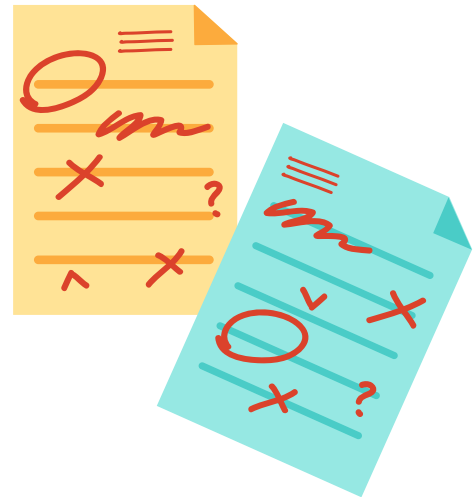



## Usability testing

Test out your instructions on someone new. Ask your tester to follow the instructions from beginning to end. If they wind up with a finished product instead of a monstrosity, then you've done your job as a writer. Be sure to ask your tester what sections were hard to understand and why.

## Update

Have a plan for updating your documentation. If you write a manual, you've got to commit yourself to keeping it relevant. Read through your documentation every six months or so to make sure that it is still up-to-date.



## You're ready

Congratulations. We tip our hat to you. Welcome to our technical writer cabal. It's small, but exclusive. We've even got a secret handshake, which we'll teach you once we acquire a secret clubhouse. But don't hold your breath. We're currently in limbo, hampered by the fact that we won't tell our real estate agent the secret location of our super-secret clubhouse.



## APPENDIX A: DEEP DIVE

# Manufacturing work instructions

Work instructions may take a lot of time to plan and create, but great instructions will significantly benefit production. They are the pathway to incremental improvement—the cornerstone of lean manufacturing.

---

Every employee has a slightly different way of doing things. Each has a different background, different experience, different depth of skill, and a slightly different work process—and that introduces variation into a company’s workflow. The larger your operation, the more variation works its way into the production line.

### Standardized work

“Standardization,” explains K. Smith of KBC Advanced Technologies, “is the process of developing, agreeing upon and implementing technical or program specifications, methods, processes and practices throughout an organization.”

The goal of standardization is to do more with less resources, less time, and less effort. You’ve probably already identified your best practices—the ones that preserve value while eliminating waste. We’re going to show you how to capture those best practices, document them, and roll them out across your workforce.

### **That sounds great. But how do I convince my boss to let me spend time writing work instructions?**

Good question! Here are a couple points that might help you make your case:

- Work instructions are key to reducing variation, allowing manufacturers to improve quality and meet demand. Even better, written work instructions are a great training tool for new employees.
- Standard work instructions enforce consistency when performing tasks. They allow engineers to measure quality and task time. Knowing those two variables is key to determining determining Takt time, which gauges how effectively manufacturers are meeting their production goals.

If you can document the improvement with fewer errors or reduced Takt time, you won't have to ask your manager for resources next time—they'll be happy to do it.

The better your work instructions are, the more efficient your workplace will be.

### Writing standardized work instructions

Great work instructions use most of the same techniques that we've already explored in the previous chapters. But there are a couple more things you'll want to keep in mind.

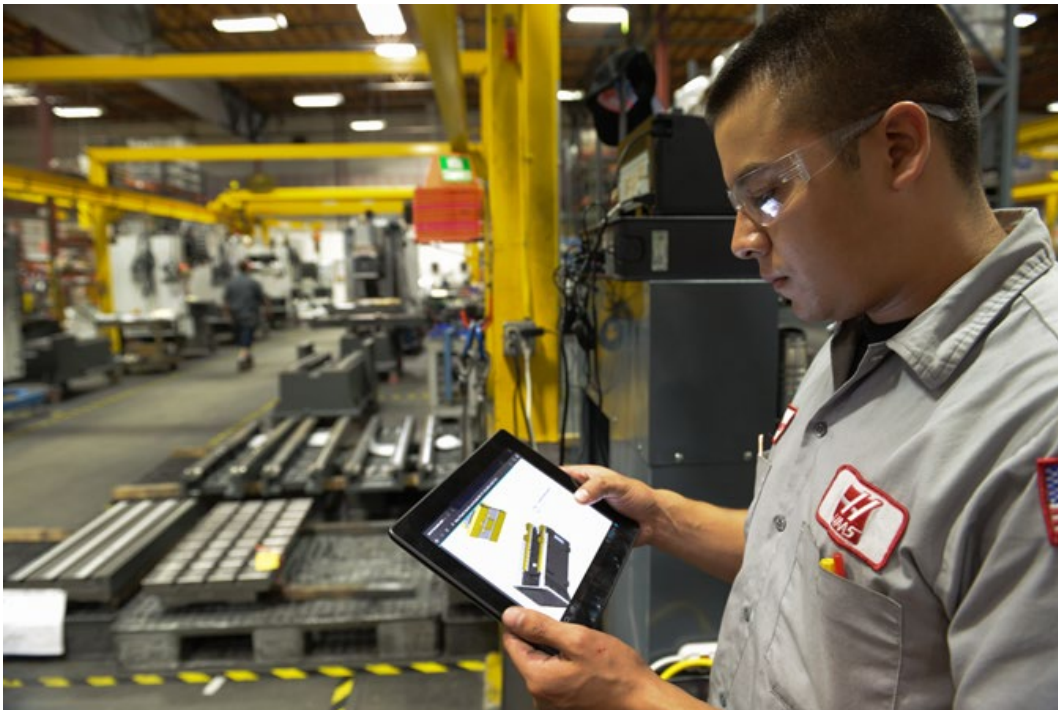

### Modularity means flexibility

Manufacturing is complex. Building a car, assembling a cell phone, and manufacturing a medical device are huge tasks. Each step along the way has to get done quickly, safely, and with

reproducible quality. It's easy to get overwhelmed by the sheer magnitude of the process.

We already touched on the importance of prerequisites: reusable procedures that are used in a number of different processes. This concept, of breaking work into repurposable chunks, is important for managing work instructions.

Think of it this way: Processes have to be done in a certain order. You can't put together a hamburger without first cooking your beef. So, grilling your burger patty is a prerequisite—a dependent task. Prepping veggies—slicing the tomatoes, washing the lettuce, cutting the onions—is also a prerequisite. As is toasting the bun.

Organizing your procedural information into prerequisite tasks is a great way to create modular instructions.

Continuing with the burger theme, here's an example: In busy restaurant kitchens, the work process is separated into modules. No single person makes the burger from beginning to end. Instead, there's a grilling station for burgers; a toasting station for buns, and a preparation station for vegetables. The modular layout allows the restaurant to respond to orders quickly and easily.

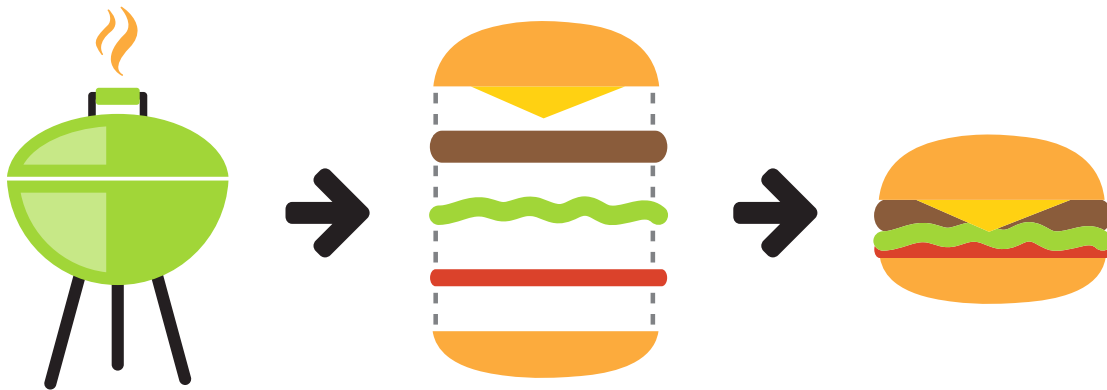

The same principles keep shops running smoothly—whether you're building power tools or refurbishing plane parts. But what if Yvonne is running behind on the prep station? You might give some of her work (slicing tomatoes) to Stefan to do before he toasts the buns.

### Modular work instructions enable line balancing

You can use your documentation system to level out your workload (and balance your line) by moving processes from one station to another. Your team can react quickly by transferring discrete processes to underutilized workstations, thereby eliminating bottlenecks.

Flexible, easy to rearrange work instructions provide a powerful tool for reducing overall takt time.

## Break it down

The best work instructions make complex processes feel simple—even when they really aren't. Break down each step in the process to its most basic elements. Here's an example from a repair procedure for an Xbox:



### Step 8 — Faceplate

Edit

- Insert the edge of a spudger between the faceplate and the outer casing near the power button.
- Run your spudger along the edge of the faceplate to release the clips securing it to the front of the console.
- You may also accomplish this task by using the edge of the Xbox 360 opening tool, but it may scratch the plastic case.
- Alternatively, you can use your hands to carefully pull the faceplate away from the Xbox.



Step 8 of the guide describes how to remove the Xbox's faceplate. Each bullet in the step details individual actions that are part of that step.

We try to keep each step pretty short, because short feels simple. If there are five “do this” bullets in a step, it's probably better to split that step into two separate steps.

## Being specific is being safe

A clear, concise style is always important. But work instructions are a little different than a product manual: you have a captive, careful audience. That means you can provide more detail than you would for a public-facing audience.

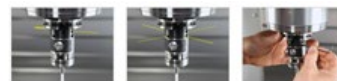

### Step 8

Edit

- On the probe body, loosen the two upper LOCKING set screws slightly, and then lightly tighten them.
- **WARNING:** The four lower sets of screws adjust the position of the stylus mount. Very small adjustments have a large effect on the stylus runout. 
- Decide which direction the stylus needs to be adjusted to reduce runout.
- Loosen and then slightly tighten the two (2) opposing screws which are NOT inline with this direction to add some friction.

Work instructions don't just standardize work, they also prevent accidents. Give your team members all of the information they need to keep themselves safe.

Here's a direction from a CNC machine operating procedure:

Remove the cutting tool.

Short, sweet, and to the point. Good enough, right? Well, it might be a little too short. How does the cutting tool come out of the machine? Should the technician apply force? Should he twist? Does it pull right out? Cutting tools are sharp, so it's a good idea to be specific. Here's a revision:

Pull the cutting tool straight down to free it from the machine.

To remove any doubts about how to perform this step, include photos or videos. Illustrating a movement with a couple hand-featured photographs, or a short video, eliminates confusion. And that's important when it comes to safety.

## Find the right balance

Visual instructions are important—as we discuss at greater length in Chapters 6 and 7—but as you're crafting operational procedures, it's important to find a balance between words and images. The two should be complementary, but each should be descriptive enough to stand on its own.

For each step, if you cover the text with your hand, the images should provide enough reference for the technician to follow the task from beginning to end. If you cover the images with your hand, the text should be good enough to stand alone as a set of instructions.

## Feedback loops are imperative

Written instructions are never done: effective, continuous improvement means constantly integrating feedback from the people on the floor actually doing the work.

Don't wait for the quality team to flag the issue further down the line. Deal with problems before they become shop stoppers. Put a system in place to capture feedback.

Giving your workers tablets is a great way to bring them into the loop. Then, you can empower workers to comment on and suggest improvements to the procedure.

---

With Dozuki, we allow workers to comment on steps within a work instruction. They can suggest improvements, ask for clarification, or identify errors as they find them. All stakeholders in the organization have a voice in the process. And everyone who helps to improve the procedure gains a sense of ownership over the process.

---

Workers know which instructions are confusing. Deputize them as adjunct members of your team. Once they know you're listening, they'll feel empowered to help you revise and improve your documentation.

Implementing standardized processes can be a tough sell on the line, particularly when people have been doing the same procedure for years. Let them know that you're not shoving a new procedure down their throat—you want to standardize the best procedure. Giving them a part in the process and integrating their feedback into your documentation is the best way to get everyone on board.



You're prepared.

**Now go forth and write instructions  
that standardize your processes.**

Visit [www.dozuki.com](http://www.dozuki.com) to learn more.